

# CLIFF

## GENDER CHANGE SOCKETS

These gender change sockets are available in both USB2 A→B and B→A versions. Designed to accommodate the integration of USB2 data feeds into professional equipment for broadcast, lighting and audio applications.

Construction is of rugged zinc/nickel metal XLR housings fitting the universally popular 23.6mm diameter XLR panel cutouts. These connectors can be mounted at rear or front of panel.

### Part No: CP30110

#### USB2 A→B GENDER CHANGE FEEDTHROUGH SOCKET

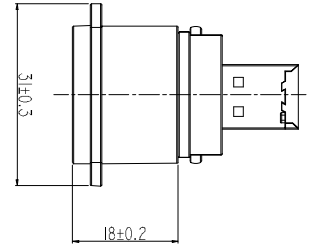
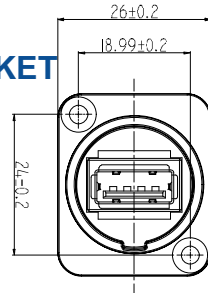

Panel cut out (Rear side)

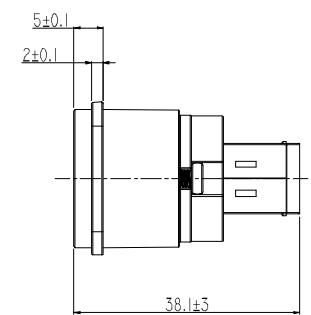
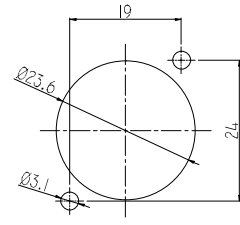

### Part No: CP30114 - Black Version



### Part No: CP30111

#### USB2 B→A GENDER CHANGE FEEDTHROUGH SOCKET

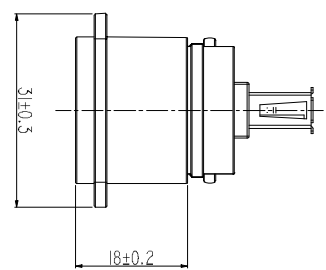
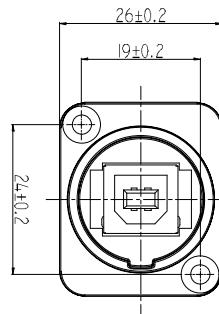

Panel cut out (Rear side)

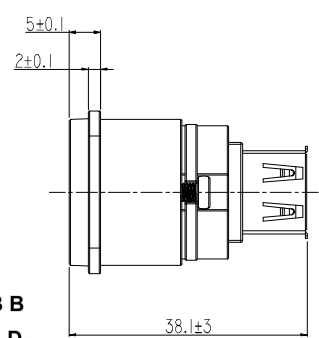
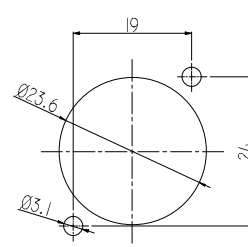

### Part No: CP30115 - Black Version



### Part No: CP30112 COVER BLACK

Optional sealing cap



#### USB SPECIFICATION

PIN No.	USB A	USB B
1	Vcc	Vcc
2	D-	D-
3	D+	D+
4	GROUND	GROUND

