



# SPECIFICATIONS

|   |                              |                                     |
|---|------------------------------|-------------------------------------|
| CUSTOMER MODEL NO. / TITLE<br>MINI DIN 4 POS WITH OPTICAL CONNECTOR | DATASHEET FOR<br>FC6842135TR | PAGE : 1 OF 7<br>DATE : OCT,05,2005 |
|---|------------------------------|-------------------------------------|

**1. Scope**

This specification covers the requirements for I/O signal and video machine connecting with optical connector.

**2. Adapted plug**

Adapted plug as Fig.4.

**3. The outlook structure and dimension**

The outlook and plated stripped with vision shall be capable of correct using and without loosing and breakdown.

**4. Rated**

- 4-1 Temperature and humidity range for using: -25~70 °C, 85% RH max.
- 4-2 Temperature and humidity range for storage: -40~70 °C, 85% RH max
- 4-3 Supply voltage:-0.5 to 7V
- 4-4 Input voltage:-0.5 to Vcc +0.5V
- 4-5 Operating voltage:2.75 to 5.25V
- 4-6 Signal transmission speed:16Mbps

Internal equivalent circuit

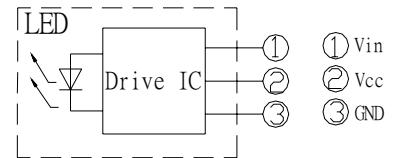

**5. Status of testing**

**5-1 Standard condition**

All measurement and tests shall be made at temperature of 15~35 °C and relative humidity of 25~80%, air pressure of 86~106kPa.

If the justification has problem, at temperature 20±2 °C and relative humidity of 60~70%, air pressure of 86~106kPa.

**5-2 After testing**

In test room at temperature of 15~35±1 °C and relative humidity of 75~77%, air pressure of 86~106kPa.

|             |             |             |               |          |         |          |         |          |         |          |         |
|-------------|-------------|-------------|---------------|----------|---------|----------|---------|----------|---------|----------|---------|
|             |             |             |               | A        | 陳       | C        | 游       | C        | 游       | W        | 簡       |
|             |             |             |               | P        | 94.10.5 | H        | 94.10.5 | H        | 94.10.5 | R        | 94.10.5 |
|             |             |             |               | V        | 必達      | K        | 大成      | K        | 竹盛      | T        | 秀陵      |
| <b>REV.</b> | <b>NAME</b> | <b>DATE</b> | <b>REMARK</b> | <b>D</b> |         | <b>D</b> |         | <b>D</b> |         | <b>N</b> |         |

**Cliff Electronic Components Ltd.**

76 Holmethorpe Avenue, Holmethorpe Industrial Estate,  
Redhill, Surrey, RH1 2PF, England, UK

Tel: 01737-771375 Fax: 01737-766012 Website: www.cliffuk.co.uk

# SPECIFICATIONS

|   |                              |                                     |
|---|------------------------------|-------------------------------------|
| CUSTOMER MODEL NO. / TITLE<br>MINI DIN 4 POS WITH OPTICAL CONNECTOR | DATASHEET FOR<br>FC6842135TR | PAGE : 2 OF 7<br>DATE : OCT,05,2005 |
|---|------------------------------|-------------------------------------|

## 6. Electrical efficiency

| Parameter                                | Symbol           | Conditions     | MIN. | TYP. | MAX. | Unit. |
|--|------------------|----------------|------|------|------|-------|
| Peak emission wavelength                 | $\lambda_p$      |                | 630  | 660  | 690  | nm    |
| Optical power output coupling with fiber | Pc               | Refer to Fig.1 | -21  | -18  | -15  | dBm   |
| Dissipation current                      | I <sub>cc</sub>  | Refer to Fig.2 | 3    | -    | 10   | mA    |
| High level input voltage                 | V <sub>iH</sub>  | Refer to Fig.2 | 2    | -    | -    | V     |
| Low level input voltage                  | V <sub>iL</sub>  | Refer to Fig.2 | -    | -    | 0.8  | V     |
| Low → High delay time                    | t <sub>pLH</sub> | Refer to Fig.3 | -    | -    | 120  | ns    |
| High → Low delay time                    | t <sub>pHL</sub> | Refer to Fig.3 | -    | -    | 120  | ns    |
| Pulse width distortion                   | $\Delta tw$      | Refer to Fig.3 | -25  | -    | 25   | ns    |
| Jitter                                   | $\Delta tj$      | Refer to Fig.3 | -    | -    | 20   | ns    |

## 7. Mechanical efficiency

| No. | Item                 | Test method  | Character   |
|-----|----------------------|--|---|
| 7-1 | Mating force         | OPTO conn. As Fig.4, use adapted gauge plug for testing.   | 39.2N max   |
| 7-2 | Withdrawal force     | OPTO conn. As Fig.4, use adapted gauge plug for testing.   | 5.9N to 39.2N   |
| 7-3 | Durability           | OPTO conn. As Fig.1, use adapted gauge plug for testing, 500cycles insertion and withdrawal.   | Satisfy with 7-1,7-2 and the outlook without breakdown or unnormal. |
| 7-4 | Chape test           | After inserting a plug (as Fig.4) for the test. It gains 5 second of upper and lower either side torque of 1N five times.  | To be mated without mechanical abnormality.                         |
| 7-5 | Vibration resistance | The test sample is soldered on the P.W.B.. And then the simple vibration which change from 10 to 55 H2, amplitude 0.75mm per minutes. Shall be applied to each of the X,Y and Z axis for 2h (a total of 6 hours) | Plug and receptacle shall not be come off during test.              |

### Cliff Electronic Components Ltd.

76 Holmethorpe Avenue, Holmethorpe Industrial Estate,  
Redhill, Surrey, RH1 2PF, England, UK  
Tel: 01737-771375 Fax: 01737-766012 Website: www.cliffuk.co.uk

# SPECIFICATIONS

|   |                              |                                     |
|---|------------------------------|-------------------------------------|
| CUSTOMER MODEL NO. / TITLE<br>MINI DIN 4 POS WITH OPTICAL CONNECTOR | DATASHEET FOR<br>FC6842135TR | PAGE : 3 OF 7<br>DATE : OCT,05,2005 |
|---|------------------------------|-------------------------------------|

## 8. Environmental test

| No. | Item                     | Test method   | Character   |
|-----|--------------------------|---|---|
| 8-1 | Humidity test            | The jack shall be subjected to temperature $40\pm 2^{\circ}\text{C}$ and relative humidity of 90~95% for 240 h. Upon completion of the exposure, dewdrops shall be blown out and removed from the jack, after which the jack shall be conditioned at room ambient conditions for 1.5~2hours.  | Satisfy with 7-1,7-2 the outlook without unnormal. (OPTO) |
| 8-2 | Temperature cycling test | Take forth and back cycles 5 times form the adapted plug and jack. Upon completion of above process for 1.5~2 hours.<br>Execute the temperature testing as following. <div style="text-align: center; margin-top: 10px;"> <p>The diagram shows a temperature profile with two horizontal segments. The upper segment is at <math>70^{\circ}\text{C}</math> and the lower segment is at <math>-25^{\circ}\text{C}</math>. Each segment has a duration of <math>0.5\text{H}</math>, indicated by double-headed arrows below the segments. Vertical lines connect the two segments, representing the transition between temperatures.</p> </div> |   |
| 8-3 | Dry heat                 | The test sample shall be left at a temperature of $70\pm 2^{\circ}\text{C}$ for 240h. And then it shall be kept under standard atmospherics condition for 1h, after which measurement shall be made. (Refer to JIS C 0021)  | Satisfy with 7-1,7-2 the outlook without unnormal. (OPTO) |
| 8-4 | Cold                     | The test sample shall be left at a temperature of $-25\pm 3^{\circ}\text{C}$ of 240h. And then it shall be kept under standard atmospheric condition for 1h, after which measurement shall be made.   |   |

### Cliff Electronic Components Ltd.

76 Holmethorpe Avenue, Holmethorpe Industrial Estate,  
 Redhill, Surrey, RH1 2PF, England, UK  
 Tel: 01737-771375 Fax: 01737-766012 Website: www.cliffuk.co.uk

# SPECIFICATIONS

|   |                              |                                     |
|---|------------------------------|-------------------------------------|
| CUSTOMER MODEL NO. / TITLE<br>MINI DIN 4 POS WITH OPTICAL CONNECTOR | DATASHEET FOR<br>FC6842135TR | PAGE : 4 OF 7<br>DATE : OCT,05,2005 |
|---|------------------------------|-------------------------------------|

| No. | Item                         | Test method  | Character   |
|-----|------------------------------|--|---|
| 8-5 | Solder ability test          | JIS C0053 rule applied use rosin liquid 25% for 3seconds.<br>Temperature of solder : 235±3 °C<br>Time of dip : 5sec<br>Length of dip : 4±0.5mm.  | A new uniform coating of solder shall be cover more than 95% of the surface being immersed. |
| 8-6 | Resistance to soldering heat | <u>Solder bath method</u><br>Solder temperature : 260 ±3 °C<br>Immersion time : 5 ± <sup>1</sup> 0 sec 、 2times<br>Immersion depth: Up to the surface of the board.<br>Thickness of printed wiring board: 1.6mm<br>Material :<br>Dimensions of component holes in the printed wiring board shall be in accordance with those specified in this specification.<br><u>Soldering iron method</u><br>Bit temperature : 380 ±10 °C<br>Application of soldering iron : 3 ± <sup>1</sup> 0 sec<br>However, excessive pressure shall not be applied to the terminal. | Satisfy with 7-1,7-2 the outlook without unnormal. (OPTO)                                   |

Remark: If the jack with “switch,, the out connector plug test is also used.

## Cliff Electronic Components Ltd.

76 Holmethorpe Avenue, Holmethorpe Industrial Estate,  
 Redhill, Surrey, RH1 2PF, England, UK  
 Tel: 01737-771375 Fax: 01737-766012 Website: www.cliffuk.co.uk

# SPECIFICATIONS

CUSTOMER MODEL NO. / TITLE  
MINI DIN 4 POS WITH OPTICAL CONNECTOR

DATASHEET FOR  
FC6842135TR

PAGE : 5 OF 7  
DATE : OCT,05,2005

Fig.1 Measuring Method of Optical Output Coupling with Fiber.

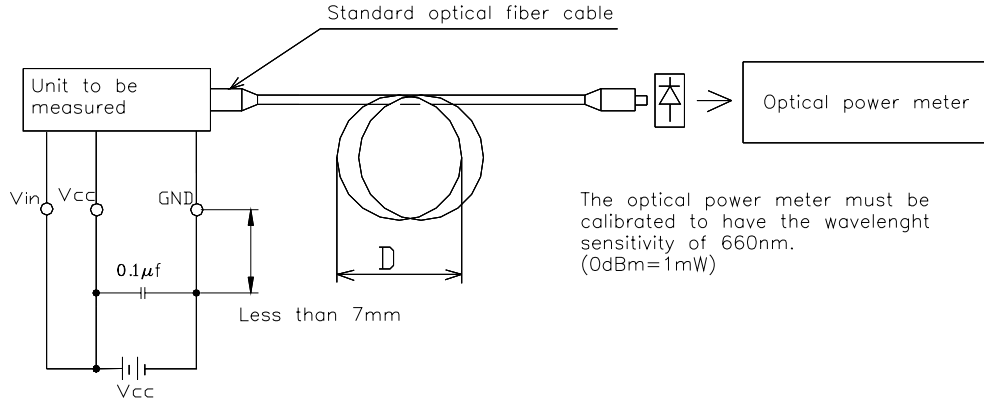

- Notes: (1) OC-08 Vcc=3.0V (State of operating).  
 (2) To bundle up the standard fiber optic cable, make it into a loop with the diameter D=10cm or more. (The standard fiber optic cable will be specified elsewhere.)

Fig.2 Measuring Method of Input Voltage and Supply Current.

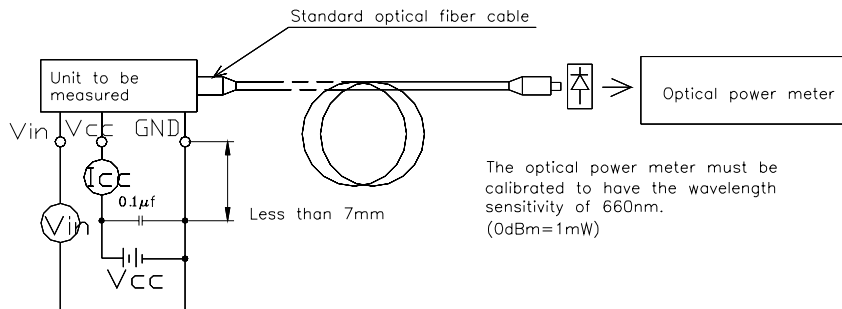

Input conditions and judgment method.

| Condition              | Judgment method                                     |
|------------------------|---|
| $V_{in}=2.1V$ or more. | $-21 \leq P_c \leq -15dBm$ , $I_{cc}=13mA$ or less. |
| $V_{in}=0.8V$ or less. | $P_c \leq -36dBm$ , $I_{cc}=13mA$ or less.          |

Note) Vcc=3.0V (State of operating).

**Cliff Electronic Components Ltd.**

76 Holmethorpe Avenue, Holmethorpe Industrial Estate,  
 Redhill, Surrey, RH1 2PF, England, UK  
 Tel: 01737-771375 Fax: 01737-766012 Website: www.cliffuk.co.uk

# SPECIFICATIONS

CUSTOMER MODEL NO. / TITLE  
MINI DIN 4 POS WITH OPTICAL CONNECTOR

DATASHEET FOR  
FC6842135TR

PAGE : 6 OF 7  
DATE : OCT,05,2005

Fig.3 Measuring Method of Pulse Response and Jitter.

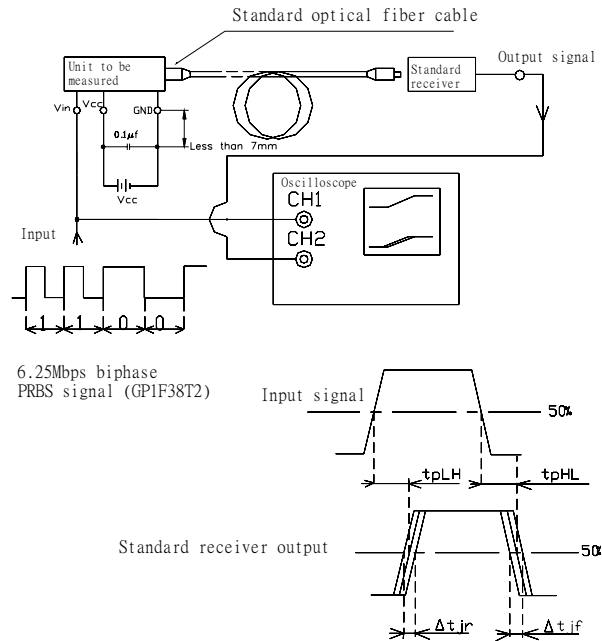

## Test item

| Test item                   | Symbol          | Test condition  |
|-----------------------------|-----------------|---|
| Low → High pulse delay time | $t_{pLH}$       | Refer o the above prescriptions   |
| High → Low pulse delay time | $t_{pHL}$       | Refer to the above prescriptions  |
| Pulse width distortion      | $\Delta tw$     | $\Delta tw = t_{pHL} - t_{pLH}$   |
| Low → High Jitter           | $\Delta t_{jr}$ | Set the trigger on the rise of input signal to measure the jitter of the rise of output |
| High → Low Jitter           | $\Delta t_{jf}$ | Set the trigger on the fall of input signal to measure the jitter of the rise of output |

- Notes: (1) The waveform write time shall be 4 seconds. But do not allow the waveform to be distorted by increasing the brightness too much.  
 (2)  $V_{cc} = 3.0V$  (State of operating)  
 (3) The probe for the oscilloscope must be more than  $1M\Omega$  and less than 10pF.

## Cliff Electronic Components Ltd.

76 Holmethorpe Avenue, Holmethorpe Industrial Estate,  
 Redhill, Surrey, RH1 2PF, England, UK  
 Tel: 01737-771375 Fax: 01737-766012 Website: www.cliffuk.co.uk

# SPECIFICATIONS

CUSTOMER MODEL NO. / TITLE  
MINI DIN 4 POS WITH OPTICAL CONNECTOR

DATASHEET FOR  
FC6842135TR

PAGE : 7 OF 7  
DATE : OCT,05,2005

Fig.4 Adapted plug

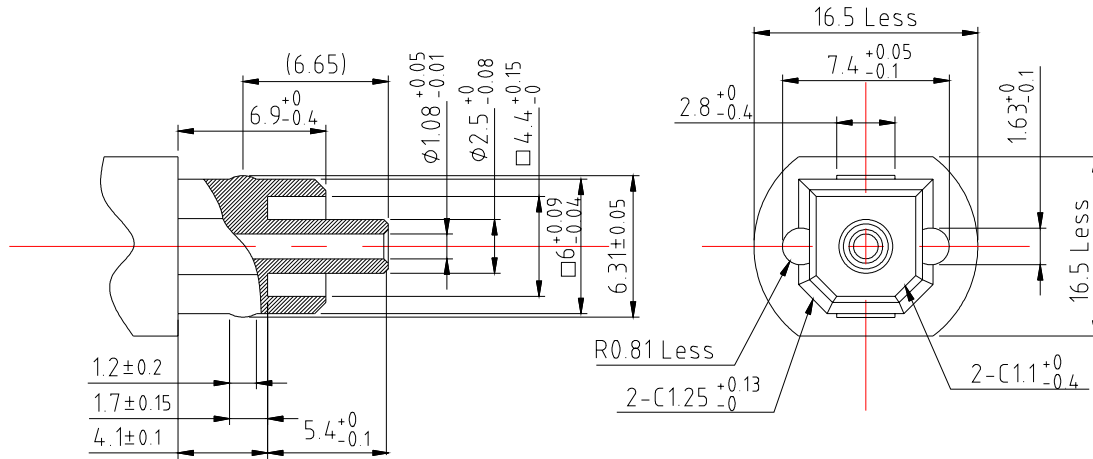

Unit:mm

**Cliff Electronic Components Ltd.**

76 Holmethorpe Avenue, Holmethorpe Industrial Estate,  
Redhill, Surrey, RH1 2PF, England, UK  
Tel: 01737-771375 Fax: 01737-766012 Website: www.cliffuk.co.uk



# SPECIFICATIONS

|  |                              |                                    |
|--|------------------------------|------------------------------------|
| CUSTOMER MODEL NO. / TITLE<br>OPTICAL RECEIVING JACK | DATASHEET FOR<br>FC6842135TR | PAGE : 1 OF 7<br>DATE : APR,0,2003 |
|--|------------------------------|------------------------------------|

Fiber optic receiving module for digital audio interface and navigation system.

Features:

- (1) Conform to EIAJ standard CP-1201 (for Digital Audio interfaces Including Fiber Optical inter-connectors).
- (2) A self-tapping hole for easy attachment to Audio Equipments panels.
- (3) High speed signal receiving  
(12.5Mbps NRZ signal)

### 1. Maximum Ratings

(Ta=25°C)

| Parameter                 | Symbol           | Rating   | Unit |
|---------------------------|------------------|----------|------|
| Storage Temperature       | T <sub>stg</sub> | -40 ~ 70 | °C   |
| Operating Temperature     | T <sub>opr</sub> | -20 ~ 70 | °C   |
| Supply Voltage            | V <sub>cc</sub>  | -0.5 ~ 6 | V    |
| High Level Output Current | I <sub>OH</sub>  | -1       | mA   |
| High Level Output Current | I <sub>OL</sub>  | 5        | mA   |
| Soldering Temperature     | T <sub>sol</sub> | 260 (1)  | °C   |

Note (1): Soldering time ≤ 10 seconds (At a distance of 1mm from the package.)

### 2. Recommended Operating Conditions

| Parameter      | Symbol          | MIN. | TYP. | MAX. | Unit |
|----------------|-----------------|------|------|------|------|
| Supply Voltage | V <sub>cc</sub> | 4.75 | 5.0  | 5.25 | V    |

|             |             |             |               |   |                   |   |  |   |  |   |
|-------------|-------------|-------------|---------------|---|-------------------|---|--|---|--|---|
|             |             |             |               | A |                   | C |  | C |  | W |
|             |             |             |               | P | 陳<br>92.4.9<br>文昌 | H |  | H |  | R |
|             |             |             |               | V |                   | K |  | K |  | T |
| <b>REV.</b> | <b>NAME</b> | <b>DATE</b> | <b>REMARK</b> | D |                   | D |  | D |  | N |

## Cliff Electronic Components Ltd.

76 Holmethorpe Avenue, Holmethorpe Industrial Estate,  
Redhill, Surrey, RH1 2PF, England, UK  
Tel: 01737-771375 Fax: 01737-766012 Website: www.cliffuk.co.uk

# SPECIFICATIONS

|  |                              |                                    |
|--|------------------------------|------------------------------------|
| CUSTOMER MODEL NO. / TITLE<br>OPTICAL RECEIVING JACK | DATASHEET FOR<br>FC6842135TR | PAGE : 2 OF 7<br>DATE : APR,0,2003 |
|--|------------------------------|------------------------------------|

### 3. Optical-electro Characteristics (Ta = 25°C, Vcc = 5V)

| Parameter                  | Symbol      | Conditions   | MIN. | TYP. | MAX.  | Unit. |
|----------------------------|-------------|--|------|------|-------|-------|
| Data Rate                  |             | NRZ Code (2)   | 0.1  | -    | 12.5  | Mb/s  |
| Transmission Distance      |             | Using APF (3)  | 0.2  | -    | 5     | M     |
| Pulse Width Distortion (4) | $\Delta tw$ | Pulse Width = 147ns<br>Pulse Cycle = 294ns<br>$C_L = 10pF$ | -15  | -    | 15    | ns    |
| Maximum Receivable Power   | $P_{MAX}$   | 12.5Mb/s, Using APF  | -    | -    | -14.5 | dBm   |
| Minimum Receivable Power   | $P_{MIN}$   | 12.5Mb/s, Using APF  | -24  | -    | -     | dBm   |
| Current Consumption        | $I_{CC}$    |  | -    | 15   | 40    | mA    |
| High Level Output Voltage  | $V_{OH}$    |  | 2.4  | 4.8  | Vcc   | V     |
| Low Level Output Voltage   | $V_{OL}$    |  | -    | 0.2  | 0.4   | V     |
| Rise time                  | $t_r$       | Refer to "Test Circuit,,                                   | -    | 10   | 20    | ns    |
| Fall time                  | $t_f$       | Refer to "Test Circuit,,                                   | -    | 10   | 20    | ns    |
| Low→High delay time        | $t_{pLH}$   | Refer to "Test Circuit,,                                   | -    | 100  | 180   | ns    |
| High→Low delay time        | $t_{pHL}$   | Refer to "Test Circuit,,                                   | -    | 100  | 180   | ns    |

Note (2): When non-modulated signal (optical all high or all low level signal) is inputted, output signal is not stable.

When modulated optical high level signal is received, output signal is high.

When modulated optical low level signal is received, output signal is low.

The duty factor must be maintained between 25 to 75%.

Note (3): All Plastic Fiber (970 / 1000 $\mu$ m).

Note (4): Between input of transmitting module and output

### 4. Mechanical Characteristics (Ta= 25°C)

4-1

| Parameter           | Condition                        | MIN. | TYP. | MAX. | Unit   |
|---------------------|----------------------------------|------|------|------|--------|
| Insertion Force.    |                                  | -    | -    | 40   | N      |
| Withdrawal Force.   | Initial value                    | 4    | -    | 40   | N      |
| Torque for Self-Tap | Using self-tapping Screw (TP3×8) | 58.8 | -    | 78.4 | N · cm |

|             |             |             |               |          |          |          |          |
|-------------|-------------|-------------|---------------|----------|----------|----------|----------|
|             |             |             |               |          |          |          |          |
|             |             |             |               |          |          |          |          |
|             |             |             |               |          |          |          |          |
| <b>REV.</b> | <b>NAME</b> | <b>DATE</b> | <b>REMARK</b> | <b>A</b> | <b>C</b> | <b>C</b> | <b>W</b> |
|             |             |             |               | <b>P</b> | <b>H</b> | <b>H</b> | <b>R</b> |
|             |             |             |               | <b>V</b> | <b>K</b> | <b>K</b> | <b>T</b> |
|             |             |             |               | <b>D</b> | <b>D</b> | <b>D</b> | <b>N</b> |



## Cliff Electronic Components Ltd.

76 Holmethorpe Avenue, Holmethorpe Industrial Estate,  
Redhill, Surrey, RH1 2PF, England, UK

Tel: 01737-771375 Fax: 01737-766012 Website: www.cliffuk.co.uk

# SPECIFICATIONS

|  |                              |                                    |
|--|------------------------------|------------------------------------|
| CUSTOMER MODEL NO. / TITLE<br>OPTICAL RECEIVING JACK | DATASHEET FOR<br>FC6842135TR | PAGE : 3 OF 7<br>DATE : APR,0,2003 |
|--|------------------------------|------------------------------------|

## TEST CIRCUIT

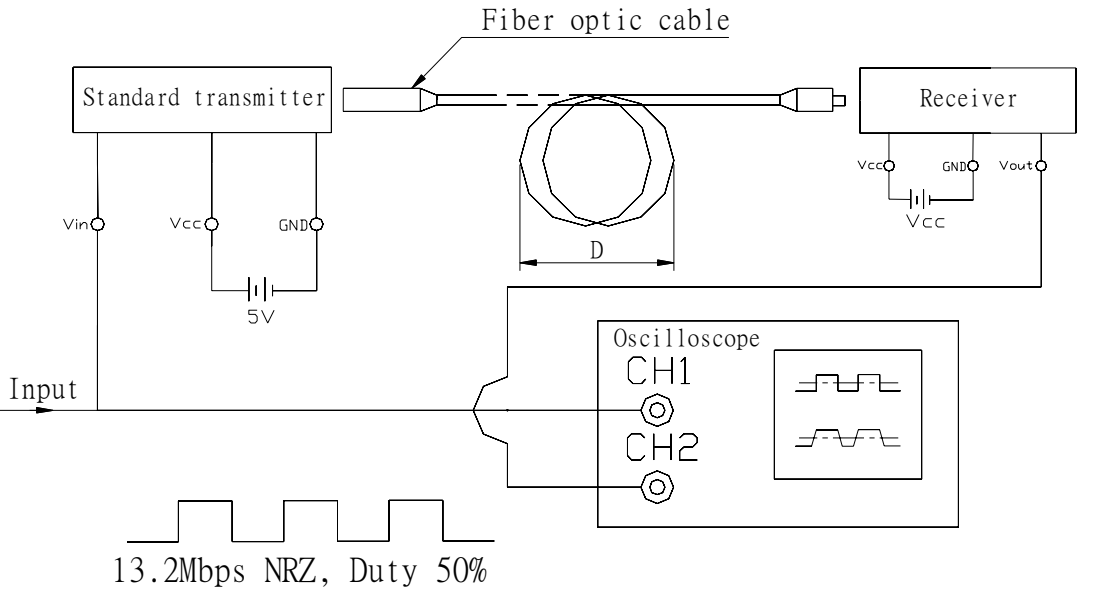

## Test item

| Test item   | Symbol      |
|---|-------------|
| Low → High pulse delay time                               | $t_{PLH}$   |
| High → Low pulse delay time                               | $t_{PHL}$   |
| Rise time   | $t_r$       |
| Fall time   | $t_f$       |
| Pulse width distortion<br>$\Delta tw = t_{PHL} - t_{PLH}$ | $\Delta tw$ |
| High level output voltage                                 | $V_{OH}$    |
| Low level output voltage                                  | $V_{OL}$    |

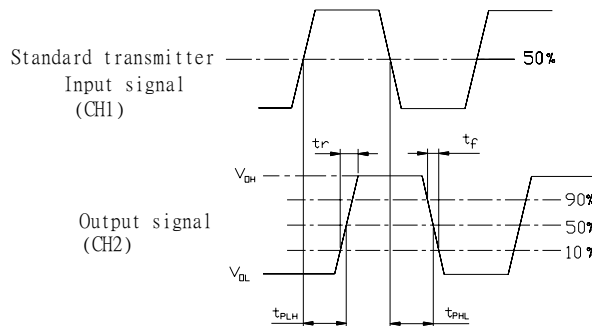

## Notes:

- 1) Vcc: 5V (State of operation)
- 2) To bundle up the standard fiber optic cable. Mark it into a loop with the diameter D=10cm.

|      |      |      |        |   |                   |   |  |                   |  |   |
|------|------|------|--------|---|-------------------|---|--|-------------------|--|---|
|      |      |      |        | A |                   | C |  | C                 |  | W |
|      |      |      |        | P | 陳<br>92.4.9<br>文昌 | H |  | 李<br>92.4.7<br>宗暉 |  | R |
|      |      |      | V      | K |                   |   |  |                   |  | T |
| REV. | NAME | DATE | REMARK | D |                   | D |  |                   |  | N |

## Cliff Electronic Components Ltd.

76 Holmethorpe Avenue, Holmethorpe Industrial Estate,  
Redhill, Surrey, RH1 2PF, England, UK  
Tel: 01737-771375 Fax: 01737-766012 Website: www.cliffuk.co.uk

# SPECIFICATIONS



|  |                              |                                    |
|--|------------------------------|------------------------------------|
| CUSTOMER MODEL NO. / TITLE<br>OPTICAL RECEIVING JACK | DATASHEET FOR<br>FC6842135TR | PAGE : 4 OF 7<br>DATE : APR,0,2003 |
|--|------------------------------|------------------------------------|

## 5. Application Circuit

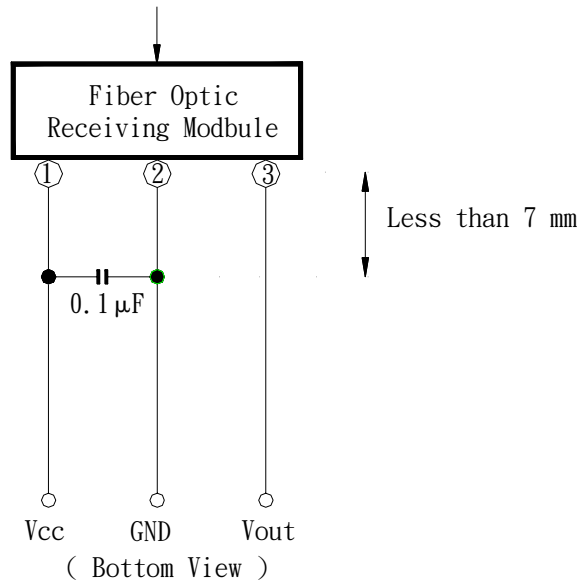
Fiber optic connector insertion side



## 6. Required Optical Fiber with Fiber Optic Connectors

|             |             |             |               |   |   |   |   |   |   |   |
|-------------|-------------|-------------|---------------|---|---|---|---|---|---|---|
|             |             |             |               | A |   | C |   | C   |   | W   |
|             |             |             |               | P |  | H |   |  | R |  |
|             |             |             |               | V |   | K | D |   | T |   |
| <b>REV.</b> | <b>NAME</b> | <b>DATE</b> | <b>REMARK</b> | D |   | D | D |   | N |   |

### Cliff Electronic Components Ltd.

76 Holmethorpe Avenue, Holmethorpe Industrial Estate,  
Redhill, Surrey, RH1 2PF, England, UK  
Tel: 01737-771375 Fax: 01737-766012 Website: www.cliffuk.co.uk

# SPECIFICATIONS

|  |                              |                                    |
|--|------------------------------|------------------------------------|
| CUSTOMER MODEL NO. / TITLE<br>OPTICAL RECEIVING JACK | DATASHEET FOR<br>FC6842135TR | PAGE : 5 OF 7<br>DATE : APR,0,2003 |
|--|------------------------------|------------------------------------|

7. Precautions on Use

(1) Maximum rating

The maximum ratings are the limit values which must not be exceeded during operation of device. None of these rating value must not be exceeded. If the maximum rating value is exceeded, the characteristics of devices may never be restored properly. In extreme cases, the device may be permanently damages.

(2) Soldering

Optical modules are comprised of internal semiconductor devices. However, in principle, optical modules are optical components. During soldering, ensure that flux does not contact with the emitting surface or the detecting surface. Also ensure that proper flux removal is conducted after soldering.

Some optical modules come with a protective cap. The protective cap is used to avoid malfunction when the optical module is not in use. Note that it is not dust or waterproof.

As mentioned before, optical modules are optical components. Thus, in principle, soldering where there may be flux residue and flux removal after soldering is not recommended. **CLIFF** recommend that soldering be performed without the optical module mounted on the board.



Then, after the board has been cleaned, the optical module should be soldered on to the board manually.

If the optical module cannot be soldered manually, use non-halogen (chlorine-free) flux and make sure, without cleaning, there is no residue such as chlorine. This is one of the ways to eliminate the effects of flux. In such a cases, be sure to check the devices' reliability.

(3) Noise resistance

It is believed that the use of optical transfer devices improve noise resistance. In theory, optical fiber is not affected by noise at all. However, receiving modules which handle signals whose level is extremely small, are susceptible to noise.

The optical module is to be used in an area which is susceptible to radiated noise, increase the shielding by covering the optical module and the power line filter with a metallic cover.

|             |             |             |               |          |   |          |  |          |   |          |
|-------------|-------------|-------------|---------------|----------|---|----------|--|----------|---|----------|
|             |             |             |               | <b>A</b> |   | <b>C</b> |  | <b>C</b> |   | <b>W</b> |
|             |             |             |               | <b>P</b> |  | <b>H</b> |  | <b>H</b> |  | <b>R</b> |
|             |             |             |               | <b>V</b> |   | <b>K</b> |  | <b>K</b> |   | <b>T</b> |
| <b>REV.</b> | <b>NAME</b> | <b>DATE</b> | <b>REMARK</b> | <b>D</b> |   | <b>D</b> |  | <b>D</b> |   | <b>N</b> |

**Cliff Electronic Components Ltd.**

76 Holmethorpe Avenue, Holmethorpe Industrial Estate,  
Redhill, Surrey, RH1 2PF, England, UK  
Tel: 01737-771375 Fax: 01737-766012 Website: www.cliffuk.co.uk

# SPECIFICATIONS

|  |                              |                                    |
|--|------------------------------|------------------------------------|
| CUSTOMER MODEL NO. / TITLE<br>OPTICAL RECEIVING JACK | DATASHEET FOR<br>FC6842135TR | PAGE : 6 OF 7<br>DATE : APR,0,2003 |
|--|------------------------------|------------------------------------|

(4) Vibration and shock

This module is plastic sealed and has its wire fixed by resin. This structure is relatively resistant to vibration and shock. In actual equipment, there are sometime cases in which vibration, shock, or tress is applied to soldered parts or connected parts, resulting in lines cut.

A care must be taken in the design of equipment which will be subject to high levels of vibration.

(5) Support pins

The jack has support pins in order to fix itself to the PCB temporary. Please make the hole for these pins in the PCB under the condition described in board layout hole pattern.

(6) Panel attachment

jack has hole for panel attachment. Please be sure to attach it to panel with self-tapping screw.

(7) Solvent

When using solvent for flux removal, do not use a high acid or high alkali solvent. Be careful not to pour solvent in to the optical connector ports. If solvent is inadvertently poured in to them, clean it off using cotton tips.

(8) Supply voltage

Use the supply voltage within the recommended operating condition ( $V_{cc} = 5 \pm 0.25V$ ). Make sure that supply voltage does not exceed the maximum rating value of 7V, even for an instant.

(9) Interface

The jack has a TTL interface. It can be interfaced with any TTL-compatible C-MOS IC.

(10) Output

If the receiver output is at low and is connected to the power supply, or if the output is high and is connected to GND, the internal IC may be destroyed.

(11) Soldering condition



Solder at 260°C or less for no more than ten seconds.

(12) Repeated operation:

Inserting and withdrawing shall be made at a speed of 20 times or less/min using mating plug (Refer to clause 4). 500 times.

(13) Precautions when disposing of devices and packing materials.

When disposing devices and packing materials, follow the procedures stipulated by local regulations in order to protect the environment against contamination.

|             |             |             |               |   |   |   |   |   |   |   |
|-------------|-------------|-------------|---------------|---|---|---|---|---|---|---|
|             |             |             |               | A |   | C |   | C |   | W   |
|             |             |             |               | P |  | H |   | H |  | R   |
|             |             |             | V             | K |   | K | T |   |   |   |
| <b>REV.</b> | <b>NAME</b> | <b>DATE</b> | <b>REMARK</b> | D |   | D | D | N |   |  |

**Cliff Electronic Components Ltd.**

76 Holmethorpe Avenue, Holmethorpe Industrial Estate,  
Redhill, Surrey, RH1 2PF, England, UK  
Tel: 01737-771375 Fax: 01737-766012 Website: www.cliffuk.co.uk

# SPECIFICATIONS

|  |                              |                                    |
|--|------------------------------|------------------------------------|
| CUSTOMER MODEL NO. / TITLE<br>OPTICAL RECEIVING JACK | DATASHEET FOR<br>FC6842135TR | PAGE : 7 OF 7<br>DATE : APR,0,2003 |
|--|------------------------------|------------------------------------|

(14) Precautions during use

**CLIFF** is continually working to improve the quality and the reliability of their products. Nevertheless, semiconductor devices in general can malfunction or fail due to their inherent electrical sensitivity and their vulnerability to physical stress. It is the responsibility of the buyer, when utilizing **CLIFF** products, to observe standards of safety, and to avoid situations in which the malfunction or failure of a **CLIFF** product could cause loss of human life, bodily injury or damage to property.

Mating plug

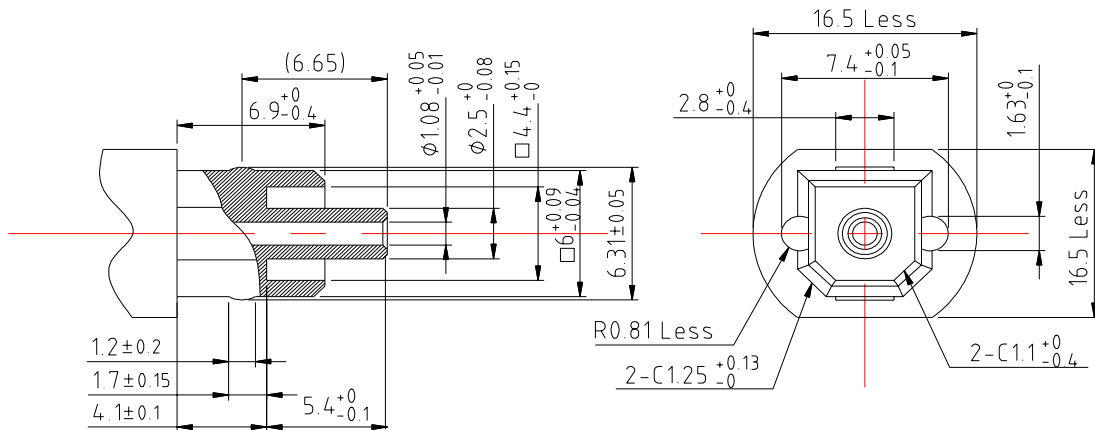

Unit:mm

|      |      |      |        |   |                   |   |   |                   |   |                   |
|------|------|------|--------|---|-------------------|---|---|-------------------|---|-------------------|
|      |      |      |        | A |                   | C |   | C                 |   | W                 |
|      |      |      |        | P | 陳<br>92.4.9<br>文昌 | H |   | 李<br>92.4.7<br>宗暉 | R | 張<br>92.4.4<br>榆珮 |
|      |      |      |        | V |                   | K | K |                   | T |                   |
| REV. | NAME | DATE | REMARK | D |                   | D | D |                   | N |                   |

**Cliff Electronic Components Ltd.**

76 Holmethorpe Avenue, Holmethorpe Industrial Estate,  
Redhill, Surrey, RH1 2PF, England, UK  
Tel: 01737-771375 Fax: 01737-766012 Website: www.cliffuk.co.uk

|              |  |      |                                     |
|--------------|--|------|-------------------------------------|
| Document No. | Document name  | Rev. | DATE                                |
| 01-E         | Management standards for "Environment-related substances to be controlled" | 1.8  | PAGE : 1 OF 2<br>DATE : APR,20,2009 |

1. This part should not contain any substances which are specified in follow .(Except cadmium is less than 5ppm, Lead is under 90ppm)
2. In this case, pre-processing methods and measurement methods shall conform to ROHS.
3. List of "Environment-related Substances to be Controlled ('The Controlled Substances')"

| Substances   |   | Allowable concentration |
|--|---|-------------------------|
| Heavy metals   | Cadmium and cadmium compounds   | Less 5ppm               |
|  | Lead and lead compounds   | Less 90ppm              |
|  | Lead in the plastic,rubber,paints,ink   | Less 50ppm              |
|  | Mercury and mercury compounds   |                         |
|  | Hexavalent chromium compounds   |                         |
|  | Nickel and Nickel compounds (at present only ASUS and Silitex)                    |                         |
| Chlorinated organic compounds  | Polychlorinated biphenyls (PCB)   |                         |
|  | Polychlorinated naphthalenes (PCN)  |                         |
|  | Short-chain chlorinated paraffins (SCCP)  |                         |
|  | Polychlorinated terphenyls (PCT)  |                         |
|  | Other chlorinated organic compounds   |                         |
| Brominated organic compounds   | Polybrominated biphenyls (PBB)  |                         |
|  | Polybrominated diphenylethers (PBDE)(including decabromodiphenyl ether [DecaBDE]) |                         |
|  | Other brominated organic compounds  |                         |
| Organic tin compounds (tributy tin compounds, Triphenyl tin compounds) |   |                         |
| Asbestos   |   |                         |
| Specific azo compounds   |   |                         |
| Formaldehyde   |   |                         |
| Polyvinyl chloride (PVC) and PVC blends                                |   |                         |
| Foaming cushion material (EPS 、 EPE 、 EPP)                             |   |                         |

|      |      |      |        |   |   |   |  |   |   |   |
|------|------|------|--------|---|---|---|--|---|---|---|
|      |      |      |        | A |   | C |  | C |   | W |
|      |      |      |        | P |  | H |  | H |  | R |
|      |      |      |        | V |   | K |  | K |   | T |
| REV. | NAME | DATE | REMARK | D |   | D |  | D |   | N |
|      |      |      |        |   |   |   |  |   |  |   |

**Cliff Electronic Components Ltd.**



| Document No. | Document name  | Rev. | DATE                                |
|--------------|--|------|-------------------------------------|
| 01-E         | Management standards for "Environment-related substances to be controlled" | 1.8  | PAGE : 2 OF 2<br>DATE : APR,20,2009 |

List of "Environment-related Substances to be Controlled ('The Controlled Substances')"

| Substances   |
|--|
| Beryllium oxide  |
| Specific phthalates (DEHP、DBP、BBP、DINP、DIDP、DNOP、DNHP) |
| Hydrofluorocarbon (HFC) 、 Perfluorocarbon (PFC)        |
| Phosphorus certificate                                 |
| Perfluorooctane sulfonates (PFOS)                      |
| Specific benzotriazole                                 |
| Cobalt dichloride                                      |
| Ozone depleting substance (ODS)                        |

4. Allowable concentrations:

Less than 90ppm is determined as an allowable total-concentration of four heavy metals (mercury, cadmium, hexavalent chromium, and lead). Less than 5ppm is determined as an allowable cadmium-concentration in a plastic (including rubber) part.

Component - Plastics

E130155

**NAN YA PLASTICS CORP PLASTICS 4TH DIV**

3RD FL, 201 TUNG HWA NORTH RD, TAIPEI TW

**1403G6****Polybutylene Terephthalate (PBT), furnished as pellets**

| Color | Min Thk<br>(mm) | Flame<br>Class | HWI | HAI | RTI  | RTI | RTI |
|-------|-----------------|----------------|-----|-----|------|-----|-----|
|       |                 |                |     |     | Elec | Imp | Str |
| ALL   | 0.75            | V-0            | 3   | 0   | 130  | 130 | 140 |
|       | 1.5             | V-0            | 2   | 0   | 130  | 130 | 140 |
|       | 3.0             | V-0            | 2   | 0   | 130  | 130 | 140 |

Comparative Tracking Index (CTI): **2**Dimensional Stability (%): **0**High-Voltage Arc Tracking Rate  
(HVTR): **1**High Volt, Low Current Arc Resis (D495): **6**Dielectric Strength (kV/mm): **33**Volume Resistivity (10<sup>x</sup> ohm-cm) : **14**

ANSI/UL 94 small-scale test data does not pertain to building materials, furnishings and related contents. ANSI/UL 94 small-scale test data is intended solely for determining the flammability of plastic materials used in the components and parts of end-product devices and appliances, where the acceptability of the combination is determined by UL.

Report Date: 1991-01-11

Last Revised: 2003-10-24

Underwriters Laboratories Inc®

**IEC and ISO Test Methods**

| Test Name                      | Test Method     | Units             | Thickness   | Value     |
|--------------------------------|-----------------|-------------------|-------------|-----------|
|                                |                 |                   | Tested (mm) |           |
| Flammability                   | IEC 60695-11-10 | Class (color)     | 0.75        | V-0 (ALL) |
|                                |                 |                   | 1.5         | V-0 (ALL) |
|                                |                 |                   | 3.0         | V-0 (ALL) |
| Glow-Wire Flammability (GWI)   | IEC 60695-2-12  | C                 | -           | -         |
| Glow-Wire Ignition (GWIT)      | IEC 60695-2-13  | C                 | -           | -         |
| IEC Comparative Tracking Index | IEC 60112       | Volts (Max)       | -           | -         |
| IEC Ball Pressure              | IEC 60695-10-2  | C                 | -           | -         |
| ISO Heat Deflection (1.80 MPa) | ISO 75-2        | C                 | -           | -         |
| ISO Tensile Strength           | ISO 527-2       | MPa               | -           | -         |
| ISO Flexural Strength          | ISO 178         | MPa               | -           | -         |
| ISO Tensile Impact             | ISO 8256        | kJ/m <sup>2</sup> | -           | -         |
| ISO Izod Impact                | ISO 180         | kJ/m <sup>2</sup> | -           | -         |
| ISO Charpy Impact              | ISO 179-2       | kJ/m <sup>2</sup> | -           | -         |

Underwriters Laboratories Inc®

Component - Plastics

E41938

**E I DUPONT DE NEMOURS & CO INC**

ENGINEERING POLYMERS, CHESTNUT RUN PLAZA, PO BOX 80713, WILMINGTON DE 19880

**101(+)(f1), 101F(+)(f1), 101L(+)(f1), E101(+)(f1), E101L(f1), 132F(+)(f1), 135F(+)(f1)**

Polyamide 66 (PA66), "Zytel", furnished as pellets

| Color | Min Thk<br>(mm) | Flame<br>Class | HWI | HAI | RTI  | RTI | RTI |
|-------|-----------------|----------------|-----|-----|------|-----|-----|
|       |                 |                |     |     | Elec | Imp | Str |
| ALL   | 0.71            | V-2            | 4   | 0   | 130  | 75  | 85  |
|       | 1.5             | V-2            | 3   | 0   | 130  | 75  | 85  |
|       | 3.0             | V-2            | 2   | 0   | 130  | 75  | 85  |
|       | 6.0             | V-2            | 2   | 0   | 130  | 75  | 85  |

Comparative Tracking Index (CTI): **0**

Dimensional Stability (%): -

High-Voltage Arc Tracking Rate  
(HVTR): **0**High Volt, Low Current Arc Resis (D495): **6**Dielectric Strength (kV/mm): **13**Volume Resistivity (10<sup>x</sup> ohm-cm) : **14****(+) - Virgin and regrind up to 50% by weight inclusive, have the same basic material characteristics.****(f1) - Suitable for outdoor use with respect to exposure to Ultraviolet Light, Water Exposure and Immersion in accordance with UL 746C.****NOTE - (1) Material designations that are color pigmented may be followed by suffix letters and numbers. (2) Material designations may be prefixed by "ZYT" for Zytel or "MIN" for Minlon or "ZEN" for Zenite or "DEL" for Delrin or "CRA" for Crastin or "RYN" for Rynite or "THX" for Thermx or "ETPV" for ETPV grades.**

ANSI/UL 94 small-scale test data does not pertain to building materials, furnishings and related contents. ANSI/UL 94 small-scale test data is intended solely for determining the flammability of plastic materials used in the components and parts of end-product devices and appliances, where the acceptability of the combination is determined by UL.

Report Date: 1996-07-29  
Last Revised: 2004-09-15

Underwriters Laboratories Inc®

**IEC and ISO Test Methods**

| Test Name                      | Test Method     | Units             | Thickness   |           |
|--------------------------------|-----------------|-------------------|-------------|-----------|
|                                |                 |                   | Tested (mm) | Value     |
| Flammability                   | IEC 60695-11-10 | Class (color)     | 0.71        | V-2 (ALL) |
|                                |                 |                   | 1.5         | V-2 (ALL) |
|                                |                 |                   | 3.0         | V-2 (ALL) |
|                                |                 |                   | 6.0         | V-2 (ALL) |
| Glow-Wire Flammability (GWFI)  | IEC 60695-2-12  | C                 | 0.71        | 960       |
|                                |                 |                   | 1.5         | 960       |
|                                |                 |                   | 3.0         | 960       |
|                                |                 |                   | 6.0         | 960       |
| Glow-Wire Ignition (GWIT)      | IEC 60695-2-13  | C                 | 0.71        | 725       |
|                                |                 |                   | 1.5         | 750       |
|                                |                 |                   | 3.0         | 800       |
|                                |                 |                   | 6.0         | 800       |
| IEC Comparative Tracking Index | IEC 60112       | Volts (Max)       | -           | -         |
| IEC Ball Pressure              | IEC 60695-10-2  | C                 | -           | -         |
| ISO Heat Deflection (1.80 MPa) | ISO 75-2        | C                 | -           | -         |
| ISO Tensile Strength           | ISO 527-2       | MPa               | -           | -         |
| ISO Flexural Strength          | ISO 178         | MPa               | -           | -         |
| ISO Tensile Impact             | ISO 8256        | kJ/m <sup>2</sup> | -           | -         |
| ISO Izod Impact                | ISO 180         | kJ/m <sup>2</sup> | -           | -         |
| ISO Charpy Impact              | ISO 179-2       | kJ/m <sup>2</sup> | -           | -         |

Underwriters Laboratories Inc®

Component - Plastics

E41938

**E I DUPONT DE NEMOURS & CO INC**

ENGINEERING POLYMERS, CHESTNUT RUN PLAZA, PO BOX 80713, WILMINGTON DE 19880

**70G13L****Polyamide 66 (PA66), glass reinforced, "Zytel", furnished as pellets**

| Color | Min Thk<br>(mm) | Flame<br>Class | RTI |     | RTI<br>Elec | RTI<br>Imp | RTI<br>Str |
|-------|-----------------|----------------|-----|-----|-------------|------------|------------|
|       |                 |                | HWI | HAI |             |            |            |
| ALL   | 0.71            | HB             | 4   | 0   | 125         | 120        | 125        |
|       | 1.5             | HB             | 4   | 0   | 125         | 120        | 125        |
|       | 3.0             | HB             | 4   | 0   | 125         | 120        | 125        |

Comparative Tracking Index (CTI): **0**Dimensional Stability (%): **0.3**High-Voltage Arc Tracking Rate  
(HVTR): **1**High Volt, Low Current Arc Resis (D495): **5**Dielectric Strength (kV/mm): **22**Volume Resistivity (10<sup>x</sup> ohm-cm) : **16**

**NOTE - (1) Material designations that are color pigmented may be followed by suffix letters and numbers. (2) Material designations may be prefixed by "ZYT" for Zytel or "MIN" for Minlon or "ZEN" for Zenite or "DEL" for Delrin or "CRA" for Crastin or "RYN" for Rynite or "THX" for Thermx or "ETPV" for ETPV grades.**

ANSI/UL 94 small-scale test data does not pertain to building materials, furnishings and related contents. ANSI/UL 94 small-scale test data is intended solely for determining the flammability of plastic materials used in the components and parts of end-product devices and appliances, where the acceptability of the combination is determined by UL.

Report Date: 1996-08-06  
Last Revised: 2003-10-24

Underwriters Laboratories Inc®

**IEC and ISO Test Methods**

| Test Name                      | Test Method     | Units             | Thickness   |            |
|--------------------------------|-----------------|-------------------|-------------|------------|
|                                |                 |                   | Tested (mm) | Value      |
| Flammability                   | IEC 60695-11-10 | Class (color)     | 0.71        | HB75 (ALL) |
|                                |                 |                   | 1.5         | HB75 (ALL) |
|                                |                 |                   | 3.0         | HB40 (ALL) |
| Glow-Wire Flammability (GWF)   | IEC 60695-2-12  | C                 | 0.71        | 650        |
|                                |                 |                   | 1.5         | 650        |
|                                |                 |                   | 3.0         | 800        |
| Glow-Wire Ignition (GWIT)      | IEC 60695-2-13  | C                 | 0.71        | 675        |
|                                |                 |                   | 1.5         | 675        |
|                                |                 |                   | 3.0         | 675        |
| IEC Comparative Tracking Index | IEC 60112       | Volts (Max)       | -           | -          |
| IEC Ball Pressure              | IEC 60695-10-2  | C                 | -           | -          |
| ISO Heat Deflection (1.80 MPa) | ISO 75-2        | C                 | -           | -          |
| ISO Tensile Strength           | ISO 527-2       | MPa               | -           | -          |
| ISO Flexural Strength          | ISO 178         | MPa               | -           | -          |
| ISO Tensile Impact             | ISO 8256        | kJ/m <sup>2</sup> | -           | -          |
| ISO Izod Impact                | ISO 180         | kJ/m <sup>2</sup> | -           | -          |
| ISO Charpy Impact              | ISO 179-2       | kJ/m <sup>2</sup> | -           | -          |

Underwriters Laboratories Inc®